

**META META SLIM Single-lever basin mixer with pop-up waste - Brushed Durabrace (23kt Gold)**

















META

33 501 662



- 125mm projection
- fixed spout
- circular, air-enriched flow
- height of mixer 134 mm
- height up to aerator 52 mm
- hole diameter 35 mm
- 2x screw-in M 8 x 1 pressure hose, leak-tested
- max. flow 5.7 l/min
- lead-free
- This product can help a building meet the requirements of Green Building Rating Systems, e.g. LEED®, BREEAM®, DGNB

Only suitable for basins with an overflow.

	Brushed Durabrace (23kt Gold)	33 501 662-28
	Chrome	33 501 662-00
	Brushed Platinum	33 501 662-06
	Platinum	33 501 662-08
	Dark Chrome	33 501 662-19
	Light Gold	33 501 662-26
	Brushed Light Gold	33 501 662-27
	Red	33 501 662-29
	Orange	33 501 662-30
	Dark Green	33 501 662-31
	Matte Black	33 501 662-33
	Brushed Bronze	33 501 662-42
	Brushed Champagne (22kt Gold)	33 501 662-46
	Champagne (22kt Gold)	33 501 662-47
	Brushed Chrome	33 501 662-93
	Brushed Dark Platinum	33 501 662-99

33 501 662  
mm [inches]

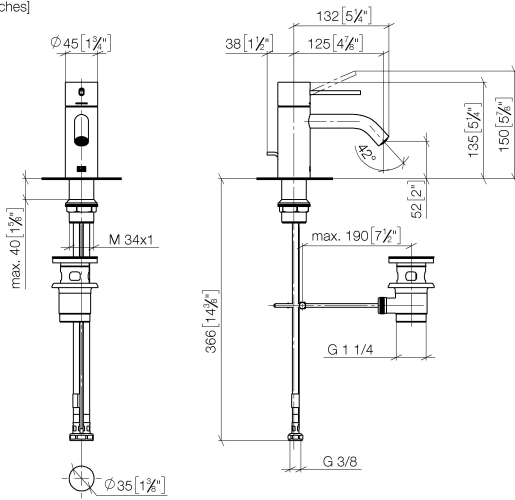

**Flow rate chart**



**Certificates**

LGA\_29706.

WRAS\_2003051.

33 501 662

Parts for other  
finishes can be found  
here: [Chrome](#)

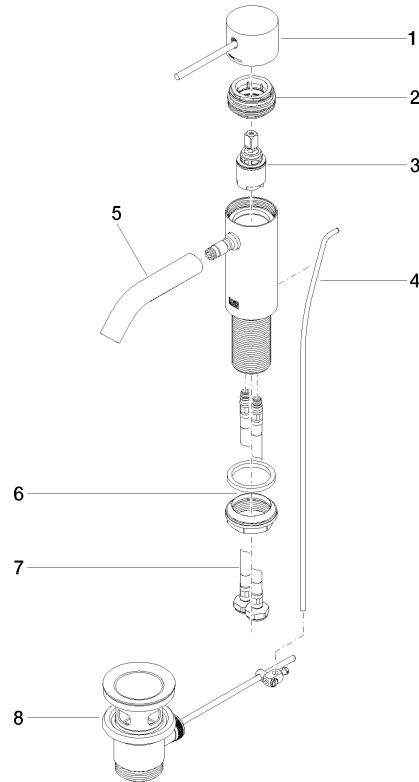

### Spare parts list

No.	Item Number	Name	Quantity used	Delivery time
1	90 20 66 020 00-28	handle	1	20
2	90 24 04 536 00 90	threaded connector	1	60
3	90 15 05 044 00 90	cartridge	1	2
4	09 31 09 110-28	pull-rod	1	20
5	90 11 06 206 00-28	spout	1	20
6	04 23 10 044 07 90	fixing set	1	2
7	04 30 04 100 00 90	hose	2	2
8	90 11 01 001 00-28	pop-up waste	1	20